



SOUTHERN CALIFORNIA
ASSOCIATION OF GOVERNMENTS
900 Wilshire Blvd., Ste. 1700
Los Angeles, CA 90017
T: (213) 236-1800
www.scag.ca.gov

REGIONAL COUNCIL OFFICERS

President
Bill Jahn, Big Bear Lake

First Vice President
Rex Richardson, Long Beach

Second Vice President
Clint Lorimore, Eastvale

Immediate Past President
**Alan D. Wapner, San Bernardino
County Transportation Authority**

COMMITTEE CHAIRS

Executive/Administration
Bill Jahn, Big Bear Lake

Community, Economic &
Human Development
**Peggy Huang, Transportation
Corridor Agencies**

Energy & Environment
Linda Parks, Ventura County

Transportation
Cheryl Viegas-Walker, El Centro

MEETING OF THE

REGIONAL TRANSIT TECHNICAL ADVISORY COMMITTEE

**Wednesday, January 29, 2020
10:00 a.m. – 12:00 Noon**

**SCAG OFFICES
900 Wilshire Blvd., Ste. 1700
Policy Meeting Room B
Los Angeles, CA 90017
(213) 236-1800**

VIDEOCONFERENCE AVAILABLE

San Bernardino SCAG Office 1170 W. 3rd Street, Suite 140 San Bernardino, CA 92418	South Bay Cities COG 20285 S. Western Avenue, Suite 100 Torrance, CA 90501
Riverside SCAG Office 3403 10th Street, Suite 805 Riverside, CA 92501	Ventura SCAG Office 4001 Mission Oaks Blvd., Ste. L Camarillo, CA 93012

TELECONFERENCE IS AVAILABLE

TO JOIN THE MEETING: <https://scag.zoom.us/j/220315897>
CONFERENCE NUMBER: 1 669 900 6833 US Toll (West Coast)
Meeting ID: 220 315 897

If members of the public wish to review the attachments or have any questions on any of the agenda items, please contact Matt Gleason at (213) 236-1832 or email gleason@scag.ca.gov

SCAG, in accordance with the Americans with Disabilities Act (ADA), will accommodate persons who require a modification of accommodation in order to participate in this meeting. SCAG is also committed to helping people with limited proficiency in the English language access the agency's essential public information and services. You can request such assistance by calling (213) 236-1908. We request at least 72 hours (three days) notice to provide reasonable accommodations and will make every effort to arrange for assistance as soon as possible.

**REGIONAL TRANSIT TECHNICAL ADVISORY COMMITTEE
AGENDA
Wednesday, January 29, 2020**

The Regional Transit Technical Advisory Committee may consider and act upon any of the items listed on the agenda regardless of whether they are listed as information or action items.

1.0 CALL TO ORDER
(Gary Hewitt, OCTA, Regional Transit TAC Chair)

2.0 PUBLIC COMMENT PERIOD - Members of the public desiring to speak on items on the agenda, or items not on the agenda, but within the purview of the Regional Transit Technical Advisory Committee, must fill out and present a speaker’s card to the assistant prior to speaking. Comments will be limited to three minutes. The chair may limit the total time for all comments to twenty (20) minutes.

3.0 <u>RECEIVE AND FILE</u>	<u>Time</u>	<u>Page</u>
3.1 <u>Minutes of the Sept. 30, 2019 RTTAC Meeting</u>		3
3.2 <u>Development of Transactional Data Specification for Demand-Responsive Transportation</u>		7
3.3 <u>Regional Transit Safety Performance Targets</u>		9
3.4 <u>Transit Ridership Update – 2018 Annual Data</u>		10
3.5 <u>FTA Accelerating Innovative Mobility (AIM) Grant Opportunity</u>		14
3.6 <u>California Air Resources Board (CARB) Innovative Clean Transit (ICT) Guidance Update</u>		16
3.7 <u>Preparing to Plug In Your Bus Fleet: 10 Things to Consider</u> https://www.apta.com/wp-content/uploads/PreparingToPlugInYourBusFleet_FINAL_2019.pdf		

4.0 INFORMATIONAL ITEMS

4.1 <u>Access Services Accessible Autonomous Vehicles</u> <i>(William Tsuei, Director of Information Technology, Access Services)</i>	20	17
--	----	----

**REGIONAL TRANSIT TECHNICAL ADVISORY COMMITTEE
AGENDA
Wednesday, January 29, 2020**

4.2	<u>ADA Paratransit Demand Forecasting Tool</u> <i>(Bruno Penet, Project Manager, HDR)</i>	20	31
4.3	<u>Bus Rapid Transit in the SCAG Region</u> <i>(Steve Fox, Senior Regional Planner, Transit/Rail, SCAG)</i>	20	45
4.4	<u>AB 1560, Friedman. California Environmental Quality Act: transportation: major transit stop</u> <i>(Philip Law, Manager, Transit/Rail, SCAG)</i>	20	62
5.0	<u>STAFF REPORT</u>		
5.1	<u>Connect SoCal Update</u> <i>(Philip Law, Manager, Transit/Rail, SCAG)</i>	5	
6.0	<u>ADJOURNMENT</u>		

The next Regional Transit Technical Advisory Committee meeting is tentatively scheduled for Monday, March 30, 2020.

Regional Transit Technical Advisory Committee (RTTAC)
of the
Southern California Association of Governments

Wednesday, September 30, 2019

Minutes

THE FOLLOWING MINUTES ARE A SUMMARY OF ACTIONS TAKEN BY THE REGIONAL TRANSIT TECHNICAL ADVISORY COMMITTEE (RTTAC). AN AUDIO RECORDING OF THE MEETING IS AVAILABLE FOR LISTENING IN SCAG'S OFFICE.

The Regional Transit Technical Advisory Committee held its meeting at SCAG's Downtown Los Angeles Office. The meeting was called to order by Chair, Gary Hewitt, Orange County Transportation Authority.

Members Present:

Gary Hewitt (Chair)	Orange County Transportation Authority
Ron Mathieu	Metrolink
Tracy Beidleman	Long Beach Transit
Teresa Wong	LACMTA
Rene Vega	Metrolink
Joel Lessard-Clouston	Metrolink
Danielle Dirksen	Metrolink
Herb Higginbotham	Cambridge Systematics

Videoconference:

Carrie Schindler	SBCTA
------------------	-------

Teleconference and Web Meeting:

Joyce Rooney (Vice Chair)	Redondo Beach Transit
Kevin Kane	Victor Valley Transit

SCAG Staff:

Philip Law	Stephen Fox
Stephen Fox	Ping Chang
Jonathan Hughes	

1.0 CALL TO ORDER

Gary Hewitt, OCTA, called the meeting to order at 10:05 a.m.

2.0 PUBLIC COMMENT PERIOD

No members of the public requested to comment.

3.0 RECEIVE AND FILE

3.1 Minutes of the July 31, 2019 RTTAC Meeting

- 3.2 ADA Paratransit Demand Forecast
- 3.3 Tactical Transit Study

4.0 INFORMATION ITEMS

4.1 Transit Asset Management Performance Target Setting

Herb Higginbotham, Cambridge Systematics, updated the committee on the transit asset management performance targets effort. He noted that transit operators' data such as asset inventories, planned investments and performance targets are being collected and aggregated for further analysis. He reviewed the target setting approach and analysis for the four asset categories of rolling stock, equipment, facilities and infrastructure as well as the possible scenarios and methodologies.

Mr. Higginbotham stated the regional rolling stock target for rolling stock is 14.8% (percent of revenue vehicles beyond the useful life benchmark), equipment target is 26.1% (non- revenue vehicles beyond useful life benchmark), facilities 10.3% (percent below TERM scale 3) and infrastructure 11.5% (percent of track with restricted segments). Additionally, using the 2019 baseline, scenarios were developed looking forward to 2045. Mr. Higginbotham noted to maintain and achieve the goals an investment of nearly \$24 billion is needed. He reviewed the next steps in the process.

Kevin Kane, Victor Valley Transit, asked if forecasts take into consideration the December 2018 CARB Innovative Clean Transit Regulation. Mr. Higginbotham responded that it does not but those would be a part of a future analysis.

Gary Hewitt, OCTA, asked how frequently updates to the database will be needed. Philip Law, SCAG staff, responded that updates will be needed every four years for the Regional Transportation Plan/Sustainable Communities Strategy. Further, based on feedback from transit operators on the current process, future efforts will be evolved for greater efficiency.

4.2 Redlands Rail Arrow Project

Carrie Schindler, San Bernardino County Transportation Authority, provided an update on the Redlands Passenger Rail Arrow Project. Ms. Schindler introduced the passenger cars to be used noting that each 2-car articulated trains can seat approximately 116 passengers and 108 standing passengers. She noted 25 daily round trips are planned between San Bernardino and Redlands. Those would depart from the San Bernardino Transit Center (SBTC) with service planned to begin early 2022. She noted Metrolink service to the SBTC was completed in 2017. Ms. Schindler stated the project involves completely reconstructing an abandoned freight corridor and she reviewed the different stations planned for the route including the Tippecanoe Avenue, ESRI, Downtown Redlands and University stations. She noted Redlands has updated their general plans to include 5 transit villages along the corridor.

Ms. Schindler stated that quiet zones, positive train control and system interoperability will be integrated into construction and operation. She noted the corridor will feature diesel multiple unit engines enabling low emissions.

Ron Mathieu, Metrolink, asked if ESRI will make space for concession vendors in the ESRI station. Ms. Schindler responded that there is interest in providing space for vendors.

Gary Hewitt, OCTA, asked if the corridor will be single or double tracked. Ms. Schindler responded that the majority of the corridor will be single track, however; there is a 2-mile passing siding in the center which allows for 30-minute bidirectional service and 20-minute service with additional vehicles.

4.3 Regional Housing Needs Assessment (RHNA) Update

Ping Chang, SCAG staff, reported on the Regional Housing Needs Assessment. He noted RHNA is a state requirement which determines housing needs over an eight-year span, currently from 2021 to 2029. He stated that there are several causes of the housing crisis now being experienced in the SCAG region. Those include misuse of CEQA as well as high construction and land costs which have resulted in insufficient housing construction for the population growth during that time. He noted a lack of housing supply results in overcrowding, outmigration and loss of talent, health and safety issues and loss of jobs.

Mr. Chang stated the goals of RHNA include increasing housing supply and mix of all housing types, promoting infill development, socioeconomic equity and protecting environmental and agricultural resources as well as improving the jobs/housing balance and to affirmatively further fair housing. He noted the RHNA final allocation would be provided in October 2020 and local jurisdictions would have one year from that time to update their housing elements. Additionally, jurisdictions may file an appeal to their draft RHNA allocation. He noted that transit accessibility is an important RHNA element and will play a critical part in the region's housing development pattern.

4.4 Draft Connect SoCal Transit/Rail Element

Philip Law, SCAG staff, updated the committee on the Draft Connect SoCal Transit/Rail element. Mr. Law stated that per capita transit ridership has been declining since 2007 and 2018 data indicates that the decline continues. This includes a decline in Metro rail ridership. He reviewed the possible causes for the decline and noted that from 2000 to 2015 the region added 2.3 million residents and 2.1 million cars or approximately 1 vehicle for each new resident. Further, vehicle ownership increased disproportionately among groups most likely to take transit. Also, the regional pool of transit riders is changing with fewer transit dependent riders and more discretionary riders. Additionally, as transportation network companies grow there is increased likelihood they will affect transit use.

Mr. Law stated Connect SoCal supports recent efforts by transit operators to reassess and modify their service including Metro’s NextGen Bus Study and OCTA’s OCBUS 360. Additionally, there is an increased focus on leveraging technology to support improved first/last mile connections, exploring on-demand service where fixed route transit isn’t cost effective and sharing best practices. He stated Connect SoCal includes mobility as a service (MaaS). This views MaaS that is not dependent on car ownership. MaaS enables multi-modal trip planning most ideally using a unified trip planning and payment system which uses transit as a backbone. Further, strategies such as parking management, congestion pricing, curb space management, dedicated transit lanes and locating housing nearer to transit are supported in Connect SoCal. He stated that capital projects include bus rapid transit and rail expansion projects including OC Streetcar, Redlands Rail and also Metrolink’s Southern California Optimized Rail Expansion (SCORE).

5.0 STAFF REPORTS

5.1 CARB Innovative Clean Transit – Upcoming Regional Meetings

Philip Law, SCAG staff, stated that California Air Resources Board will hold regional meetings to review the Innovative Clean Transit Rule. He noted there will be a meeting at Metro, Thursday, October 10, 2019 from 10:00 a.m. to 2:30 p.m. and at Omnitrans, Wednesday October 9, 2019 from 12:00 p.m. to 3:00 p.m.

5.2 Integrated Rail Forecast Study

Steve Fox, SCAG staff, stated that the Integrated Rail Forecast Study will begin soon to examine passenger rail forecasting as well as freight rail. The study will include existing conditions, rail forecasting and simulation, volumes for freight and passenger ridership as well funding strategies, identification of corridors and prioritization. Currently a technical advisory committee (TAC) is being formed and requests are being sent to regional transit professionals asking for their participation in the TAC.

6.0 ADJOURNMENT

Gary Hewitt, OCTA, adjourned the meeting at 11:43 a.m.

Southern California Association of Governments
900 Wilshire Blvd., Suite 1700, Los Angeles, CA 90017

Agenda Item 3.2
January 29, 2020

To: Regional Transit Technical Advisory Committee (RTTAC)

From: Philip Law, Transit/Rail Manager, 213-236-1841,
law@scag.ca.gov

Subject: *Development of Transactional Data Specification for Demand-Responsive Transportation*

SUMMARY:

A pre-publication draft of Transit Cooperative Research Program (TCRP) Research Report 210 is available at <http://nap.edu/25619>.

In this forthcoming TCRP report, researchers Roger Teal et al. document the development of a transactional data specification for demand responsive transportation (DRT). DRT services typically involve on-demand services (neither fixed route nor fixed schedule) where a customer requests a trip from one location to another, and a vehicle is dispatched to serve that trip. The study authors use a broad definition of DRT that includes dial-a-ride services, ADA complementary paratransit services, microtransit service, and taxi and ride-hailing services such as Uber and Lyft.

The key purpose of a transactional data specification is to enable DRT services to take advantage of the new technology innovations that have facilitated “new mobility” services including bike share, electric scooters, and ride-hailing. A transactional data specification establishes the “vocabulary” and “syntax” for how information about individual DRT trips can be transmitted from one computer system to another, including key details about the traveler, trip logistics, and other information required to successfully order, schedule and execute the trip.

The authors researched data specifications for software system interactions in transportation and other industries, and identified six core principles: simplicity, sufficiency, flexibility, adaptability, compatibility and technical appropriateness. The authors also examined five case studies of specification-based common data formats in the transportation industry: the airline industry, the General Transit Feed Specification (GTFS) for fixed route transit, the GTFS extension for flexible transit services, SUTI in Scandinavia, and a DRT trip exchange in the Denver region.

The transactional data specification recommended in the study accomplishes two objectives:

1. Establishes common language for entities to use to communicate transactional data with one another to accomplish DRT trips from the beginning to the end of the trip lifecycle

2. Provides a recommended technical approach for how data communication will occur among the inter-operating computer systems.

The report includes next steps to implement a specification, including key tools to support a “bottom-up” approach to adoption. The tools include:

- **Marketing Document** making the case for why DRT transactional data specifications are important to improve the benefits from DRT services
- **Request for Proposals (RFP) language** for public agencies procuring technology or transportation services for DRT systems to require that respondents be compliant with the proposed data specifications
- **Validation Tool** to verify that the data messages (telegrams) generated by a software system intending to communicate with another system are specification-compliant.

Southern California Association of Governments
900 Wilshire Blvd., Suite 1700, Los Angeles, CA 90017

Agenda Item 3.3
January 29, 2020

To: Regional Transit Technical Advisory Committee (RTTAC)

From: Philip Law, Transit/Rail Manager, 213-236-1841,
law@scag.ca.gov

Subject: Regional Transit Safety Performance Targets

SUMMARY:

SCAG staff previously reported to the RTTAC on the Public Transportation Agency Safety Plan (PTASP) Final Rule by the Federal Transit Administration (FTA). Transit operators receiving federal funds must develop a safety plan and annually self-certify compliance with that plan. Exceptions are made for commuter rail agencies regulated by the Federal Railroad Administration (FRA), ferries and recipients that only receive Section 5310 and/or 5311 funds.

The PTASP Final Rule includes required transit agency coordination with the metropolitan and statewide planning process, including sharing safety performance targets with the Metropolitan Planning Organization (MPO) and coordination with the MPO in the selection of MPO safety performance targets. The following guidance is taken from the FTA's **PTASP Technical Assistance Center** at <https://www.transit.dot.gov/PTASP-TAC>. Note that "Metropolitan Transportation Plan" is the same as "Regional Transportation Plan" in the SCAG region.

The PTASP rule requires transit providers to have their certified agency safety plans in place, which includes the first set of required safety performance targets, and share these targets with the MPO no later than July 20, 2020. The MPOs then have 180 days from receipt of the agency performance targets to prepare their initial public transportation safety performance targets. (23 C.F.R. § 450.306d (3)) MPOs with multiple transit providers should work with the transit providers to identify appropriate targets for that metropolitan area.

The MPO is not required to set new transit safety targets each year, but can choose to revisit the MPO's safety targets based on the schedule for preparation of its system performance report that is part of the Metropolitan Transportation Plan (MTP). **The first MPO MTP update or amendment to be approved on or after July 20, 2021, must include the adopted transit safety targets for the region.** The next MTP update, but not each MTP amendment, also includes an updated system performance report that contains the adopted transit safety targets.

SCAG staff will request safety targets from the operators beginning in July 2020, and subsequently initiate the development of initial regional safety targets in coordination with the RTTAC.

Southern California Association of Governments
 900 Wilshire Blvd., Suite 1700, Los Angeles, CA 90017

Agenda Item 3.4
January 29, 2020

To: Regional Transit Technical Advisory Committee (RTTAC)

From: Philip Law, Transit/Rail Manager, 213-236-1841,
 law@scag.ca.gov

Subject: Transit Ridership Update – 2018 Annual Data

DISCUSSION:

As part of the RTTAC’s ongoing monitoring of transit ridership trends, SCAG staff has prepared this report using the newly released 2018 annual data from the National Transit Database (NTD), available at <https://www.transit.dot.gov/ntd/data-product/ts21-service-data-and-operating-expenses-time-series-mode-2> as of Dec. 16, 2019. The data summarized in this report show that total regional bus ridership experienced a fifth consecutive year of decline in 2018, falling 3.5% from 2017 (Figure 1). However, the rate of decline has slowed significantly—regional bus ridership dropped 8.9% from 2016 to 2017 and 6.7% from 2015 to 2016.

Figure 1. SCAG Region Annual Unlinked Passenger Trips (UPTs), All Bus Modes, 2009-2018

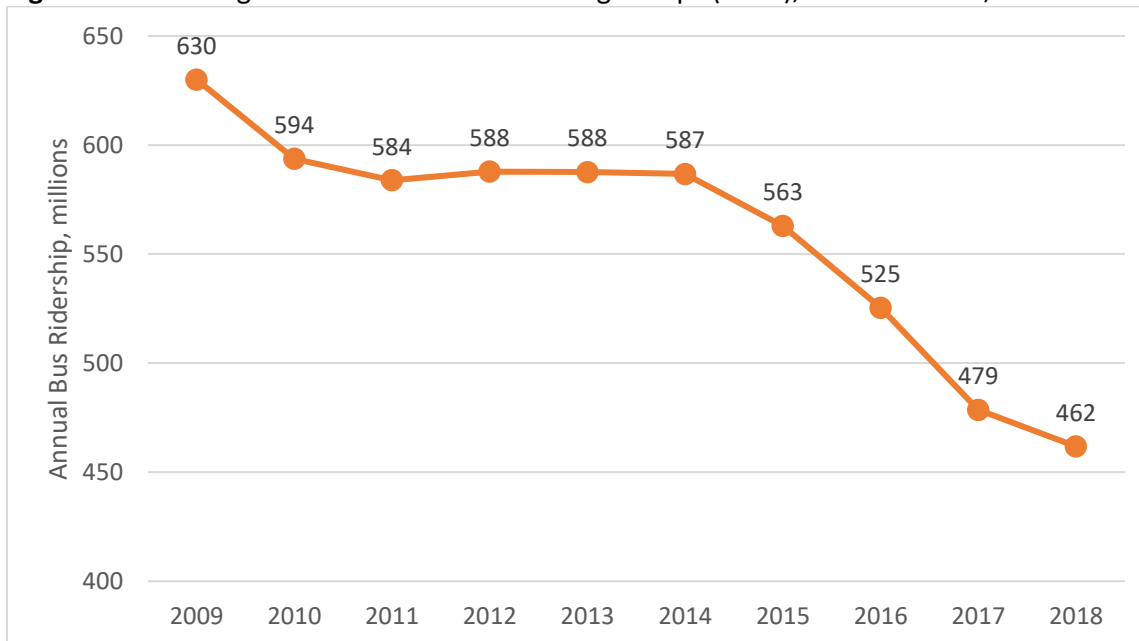

Source: National Transit Database, 2018 Annual Database

Bus ridership continued to decline in 2018 for almost all of the largest transit providers in the region (Table 1). For most of the operators shown, the rate of decline either slowed significantly or held steady.

Table 1. Annual Unlinked Passenger Trips (UPTs), millions, and Percentage Change, 2016-2018*

Bus System	2016	2017	2018	'16-17	'17-18
Metro(LACMTA)	320.87	290.00	280.79	-9.6%	-3.2%
Orange County Transportation Authority(OCTA)	43.27	39.95	39.27	-7.7%	-1.7%
Long Beach Transit(LBT)	26.27	25.22	23.78	-4.0%	-5.7%
City of Los Angeles(LADOT)	21.24	19.47	18.13	-8.4%	-6.9%
Santa Monica's Big Blue Bus(Big Blue Bus)	16.58	13.33	13.19	-19.6%	-1.1%
Foothill Transit	13.58	13.56	12.54	-0.2%	-7.5%
Omnitrans(OMNI)	12.38	11.22	10.83	-9.4%	-3.5%
Anaheim Transportation Network(ATN)	9.53	9.54	9.63	0.1%	1.0%
Riverside Transit Agency(RTA)	8.81	8.32	8.17	-5.6%	-1.8%
Montebello Bus Lines(MBL)	7.04	6.16	5.70	-12.4%	-7.5%
Culver City Municipal Bus Lines(Culver CityBus)	5.65	5.07	4.86	-10.3%	-4.1%
SunLine Transit Agency(SunLine)	4.36	4.15	3.95	-4.8%	-4.9%
Torrance Transit System(TTS)	3.79	3.83	3.71	1.1%	-3.1%
Gold Coast Transit(GCT)	3.80	3.62	3.47	-4.8%	-3.9%
City of Gardena Transportation Department(GMBL)	3.59	3.07	3.09	-14.4%	0.6%
Santa Clarita Transit(SCT)	3.07	2.76	2.67	-10.0%	-3.4%
Antelope Valley Transit Authority(AVTA)	3.03	2.53	2.44	-16.5%	-3.6%
City of Pasadena(ARTS)	1.60	1.62	1.54	1.1%	-4.7%
Victor Valley Transit Authority(VVTA)	1.99	1.74	1.52	-12.6%	-12.7%
City of Glendale	1.83	1.70	1.50	-6.8%	-11.7%
Norwalk Transit System(NTS)	1.38	1.54	1.46	11.7%	-5.1%
Los Angeles Co. - East L.A.(LACDPW)	1.07	0.89	0.89	-16.4%	-0.4%
Laguna Beach Municipal Transit(CLB)	1.08	0.90	0.84	-17.0%	-6.4%
Imperial County Transportation Commission(ICTC)	0.84	0.78	0.77	-7.1%	-1.0%
Ventura Intercity Service Transit Authority(VISTA)	0.88	0.80	0.69	-9.9%	-13.2%
City of Commerce Municipal Buslines(CBL)	0.61	0.53	0.50	-12.7%	-5.5%
City of El Monte	0.56	0.52	0.48	-7.1%	-8.4%
City of Alhambra(ALH)	0.55	0.48	0.44	-13.1%	-7.4%
City of Redondo Beach - Beach Cities Transit(BCT)	0.39	0.37	0.36	-5.6%	-2.1%
Simi Valley Transit(SVT)	0.33	0.36	0.26	9.3%	-28.2%
City of Monterey Park	0.33	0.30	0.26	-10.3%	-13.0%
Los Angeles Co. - South Whittier(LACDPW)	0.26	0.26	0.26	-0.9%	0.8%

Source: National Transit Database, 2018 Annual Database

*Notes: includes all bus modes, sorted in descending order by 2018 UPT

Unlike previous years, rail ridership in the region worsened overall from 2017 to 2018 (Figure 2 and Table 2). Metro’s light rail ridership declined by 2.0%, reversing the previous growth trend following the Gold and Expo line extensions. The decline in 2018 pre-dates the closing of the Blue Line for safety and reliability improvements in 2019. Metro’s heavy rail system saw an acceleration of ridership loss with a 4.1% decline in 2018, compared to a 0.8% loss in the previous year. For commuter rail, Metrolink’s ridership dropped slightly by 1.4% after increasing by 4.6% the previous year.

Figure 2. SCAG Region Annual Unlinked Passenger Trips (UPTs), Rail Modes, 2009-2018

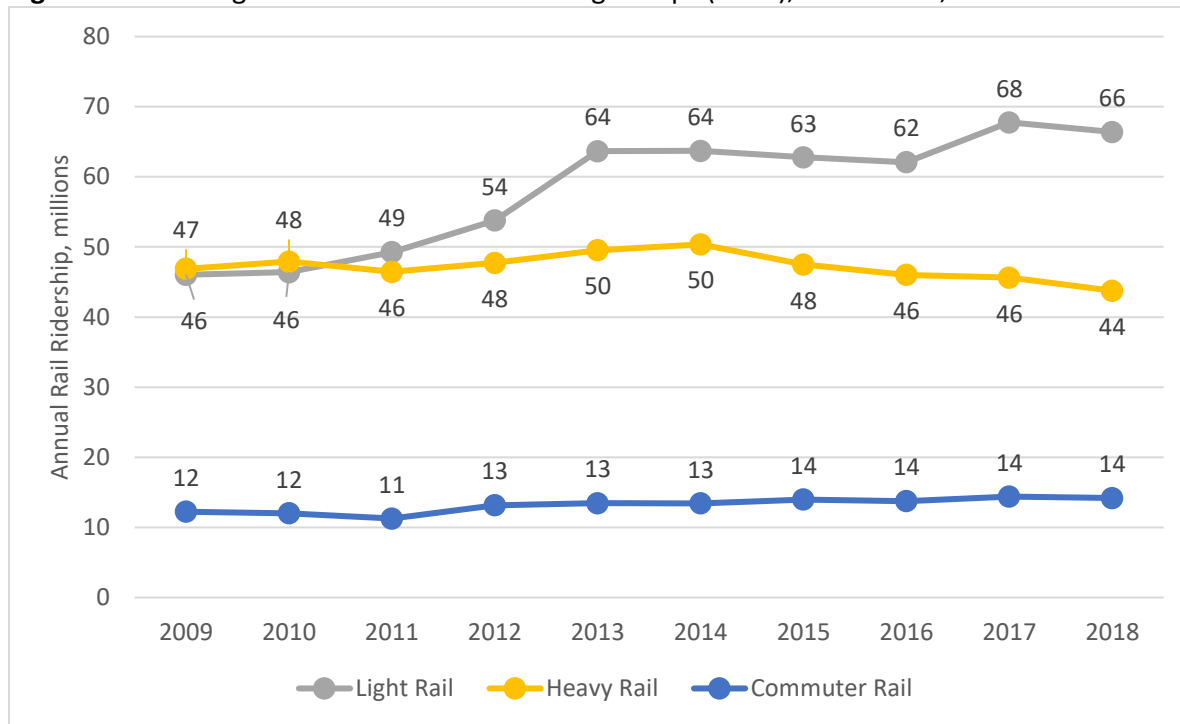

Source: National Transit Database, 2018 Annual Database

Table 2. Annual Unlinked Passenger Trips (UPTs), millions, and Percentage Change, 2016-2018*

Rail System	2016	2017	2018	'16-17	'17-18
Metro Light Rail (Blue, Green, Gold, Expo)	62.09	67.76	66.39	9.1%	-2.0%
Metro Heavy Rail (Red)	46.00	45.63	43.75	-0.8%	-4.1%
Metrolink Commuter Rail	13.76	14.40	14.19	4.6%	-1.4%

Source: National Transit Database, 2018 Annual Database

It should be noted that by 2018, the total vehicle revenue hours of bus service offered in the SCAG region has returned to the peak level seen in 2008, immediately preceding the Great Recession. As shown in Figure 3, while bus service has returned to its pre-recession peak, bus ridership has trended in the opposite direction, most noticeably from 2013 onwards. In 2018, total bus ridership was about 76% of what it was in 2005, while total bus service was 4% higher than in 2005.

Figure 3. Index of Bus UPT and Vehicle Revenue Hours (VRH), 2005 = 1.00

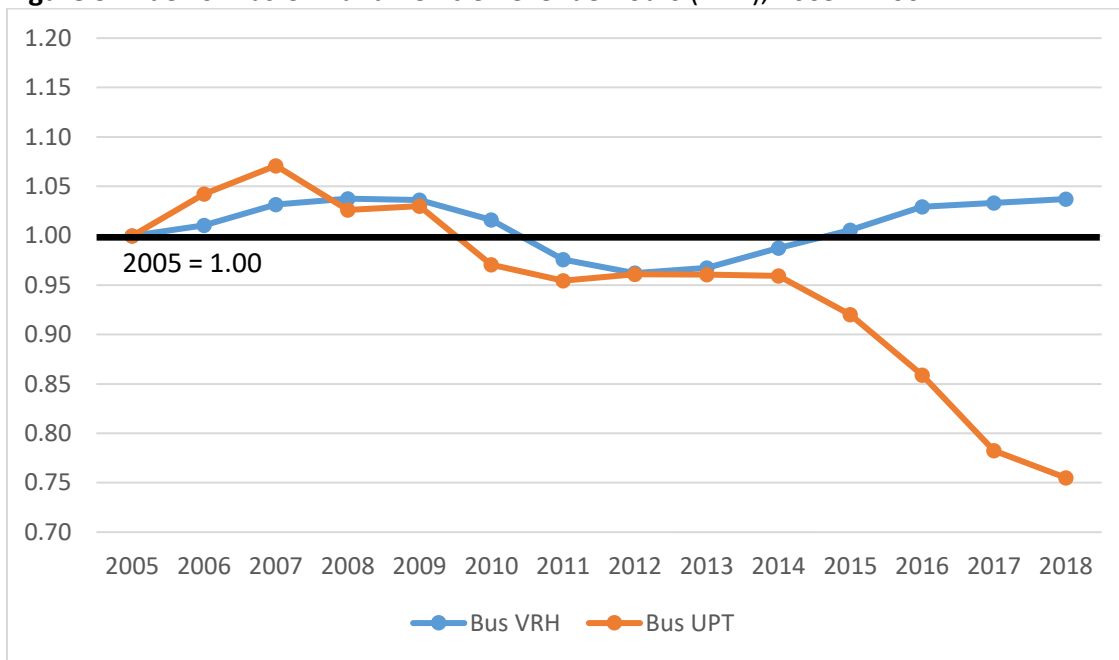

Source: National Transit Database, 2018 Annual Database

NEXT STEPS:

Staff will provide additional updates for 2019 ridership trends using the NTD’s monthly adjusted data release, once that data becomes available for the period through December 2019.

Southern California Association of Governments
900 Wilshire Blvd., Suite 1700, Los Angeles, CA 90017

Agenda Item 3.5
January 29, 2020

To: Regional Transit Technical Advisory Committee (RTTAC)

From: Philip Law, Transit/Rail Manager, 213-236-1841,
law@scag.ca.gov

Subject: Federal Transit Administration (FTA) Accelerating Innovative
Mobility (AIM) Grant Opportunity – Spring 2020

SUMMARY:

From <https://www.transit.dot.gov/AIM>:

Accelerating Innovative Mobility (AIM) will highlight FTA's commitment to support and advance innovation in the transit industry.

AIM will drive innovation by promoting forward-thinking approaches to improve financing, system design and service. Acting Administrator Jane Williams announced the plan during the Transportation Research Board Annual Meeting on January 14, 2020.

Funding

AIM will provide \$11 million in challenge grants to help transit agencies experiment with new ways of doing business, such as exploring new service models that provide more efficient and frequent service. FTA will also support outreach to both urban and rural areas to ensure widespread exposure to projects. **A Notice of Funding Opportunity for the challenge grants will be published this spring.**

FTA's Fiscal Year 2020 competitive grant programs, which will total \$615 million, will highlight innovation as part of their selection criteria. This will provide applicants with an opportunity to showcase how they can incorporate new approaches to improve the rider experience.

Technical Assistance

The AIM initiative will establish a national network of transit agencies that will test and share project results and use FTA's technical assistance centers to promote promising innovations.

FTA's Technical Assistance Centers will provide targeted technical assistance to deploy successful innovative models and develop case studies and hands-on resources. The centers will hold workshops focused on bringing together transit agencies to discuss best practices, identify barriers, and advance the adoption of new technologies and practices while ensuring safety for riders.

Accelerating Innovative Mobility (AIM)

FTA is making a commitment to lead the way in public transportation innovation. FTA's Accelerating Innovative Mobility (AIM) will advance public transit viability in the transportation network, which is evolving quickly to include new forms of mobility. AIM will continue FTA's leading role in innovation by focusing on challenges to improve transit effectiveness, efficiency and rider experience.



Innovative Service Delivery

Creative Financing



Novel Partnerships

Integrated Payment



\$11 Million

Challenge Grants to Identify Innovation Incubators

\$615 Million

Competitive Funding/ Innovative Criterion

3 Workshops

Best Practices and Collaboration on Innovation in Rural and Urban Areas.

www.transit.dot.gov/AIM

follow us on



U.S. Department of Transportation
Federal Transit Administration

Southern California Association of Governments
900 Wilshire Blvd., Suite 1700, Los Angeles, CA 90017

Agenda Item 3.6
January 29, 2020

To: Regional Transit Technical Advisory Committee (RTTAC)

From: Philip Law, Transit/Rail Manager, 213-236-1841,
law@scag.ca.gov

Subject: California Air Resources Board (CARB) Innovative Clean
Transit (ICT) Guidance Update

SUMMARY:

From <https://content.govdelivery.com/accounts/CARB/bulletins/2702de8>:

Updated Rollout Plan Guidance Document is Available for Transit Agencies

CARB has recently released a guidance package containing tools and resources that can help transit agencies to better understand the implementation and requirements of the Innovative Clean Transit (ICT) regulation. The Zero-Emission Bus Rollout Plan Guidance for Transit Agencies is one of them. This document provides implementation support on the content of the Zero-Emission Bus Rollout Plan (Rollout Plan). A Rollout Plan serves as a blueprint for full transition to zero-emission technologies. It also helps transit agencies work through many of the potential challenges and explore solutions. The ICT regulation requires large transit agencies to submit their board-approved Rollout Plan by July 1, 2020, and small transit agencies by July 1, 2023. The updated Zero-Emission Bus Rollout Plan Guidance for Transit Agencies is now available. See https://ww2.arb.ca.gov/sites/default/files/2020-01/UPDATED%20Rollout%20Plan%20Guidance%20Final_2.pdf

California Transit Agencies Have No Reporting Requirements in 2020

The Innovative Clean Transit (ICT) regulation is in effect starting October 1, 2019 and replaces the previous Fleet Rule for Transit Agencies (Fleet Rule). California transit agencies are no longer required to report and update their fleet information under the Fleet Rule. The first reporting deadline under the ICT regulation will be March 31, 2021, and this reporting requirement applies to all California public transit agencies.



From AV to AAV (Accessible Autonomous Vehicles)

William Tsuei
Director of Information Technology
ACCESS SERVICES
Tsuei@accessla.org

access

Access AAV Pilot

Benefits of Access AAV Pilot Project

- First AV project in the world to focus on paratransit and accessibility
- Will influence global AV technology and policy
- Will influence future AV vehicle design
- Benefit to personal automobile market
- Accessible autonomous vehicles will create options for people with disabilities
- Empower people with disabilities to leverage disruptive technology
- Encourage tech world to focus on disability community at nascent stage of technology development
- Focus on technology equity

access

AAV Preliminary Project Timelines

- Vehicle Creation Phase: 12 months
- Smart Infrastructure Implementation Phase: 30 months
- Testing & Tuning Phase: 18 months
- Operations Phase: 15 months
- Project Wrap-Up Phase: 3 months toward the end of the project

AAV Building Phase

Two types of purpose-built ADA designed AV will be developed:

- Chrysler Pacifica Electric Plug-In Hybrid
- Dodger ProMaster CNG

Partners:

Lilee Systems, Deloitte & Touche, Lonestar Handicap Vans, New Eagle, UC Berkeley, Wistron

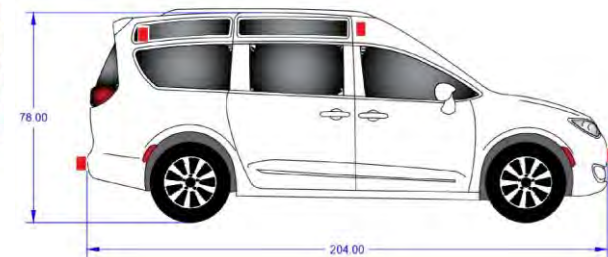

access

Onboard AV Technologies



access

Testing & Tuning Phase

Once the vehicles are built and AV enabled, they will be moved to the UC Berkeley PATH Richmond Station Facility in the Bay Area to conduct both vehicle and wayside testing & tuning. Once complete, the vehicles will move to West Los Angeles to continue service route testing & tuning.

Vendors:

AECOM, Alcatel/Lucent, Apollo Autonomous Driving, Deloitte & Touche, First Transit, Lilee Systems, MV Transportation, New Eagle, UC Berkeley



access

Mapping	Perception	Localization	Planning
GPS based	Obstacle Detection	GPS + Egomotion	Path planning solvers
Lidar based	Sensor Fusion	Lidar Localization	Scene understanding
Vision based	Segmentation	Lane Perception	Vehicle Control

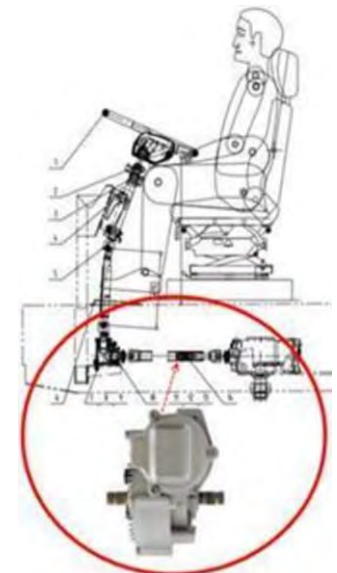

Testing & Tuning Phase

Vehicle Test Field: UC Berkeley PATH Richmond Station Facility - 400 Meters DSRC Sensor Equipped Test Route with Intelligent Traffic Signal Interaction

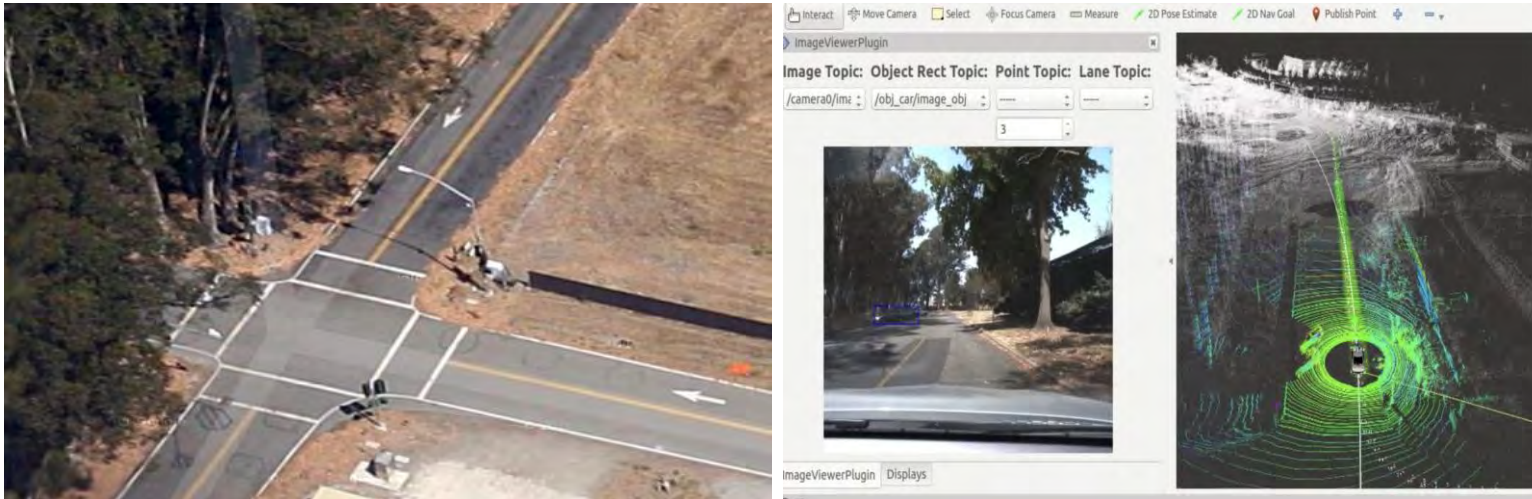

access

Testing & Tuning Phase

Test Route: Second Test will be conducted at PATH California Route 82 El Camino Real in Palo Alto – 2 Miles Stretch DSRC Sensor Embedded Route with Smart Traffic Intersections

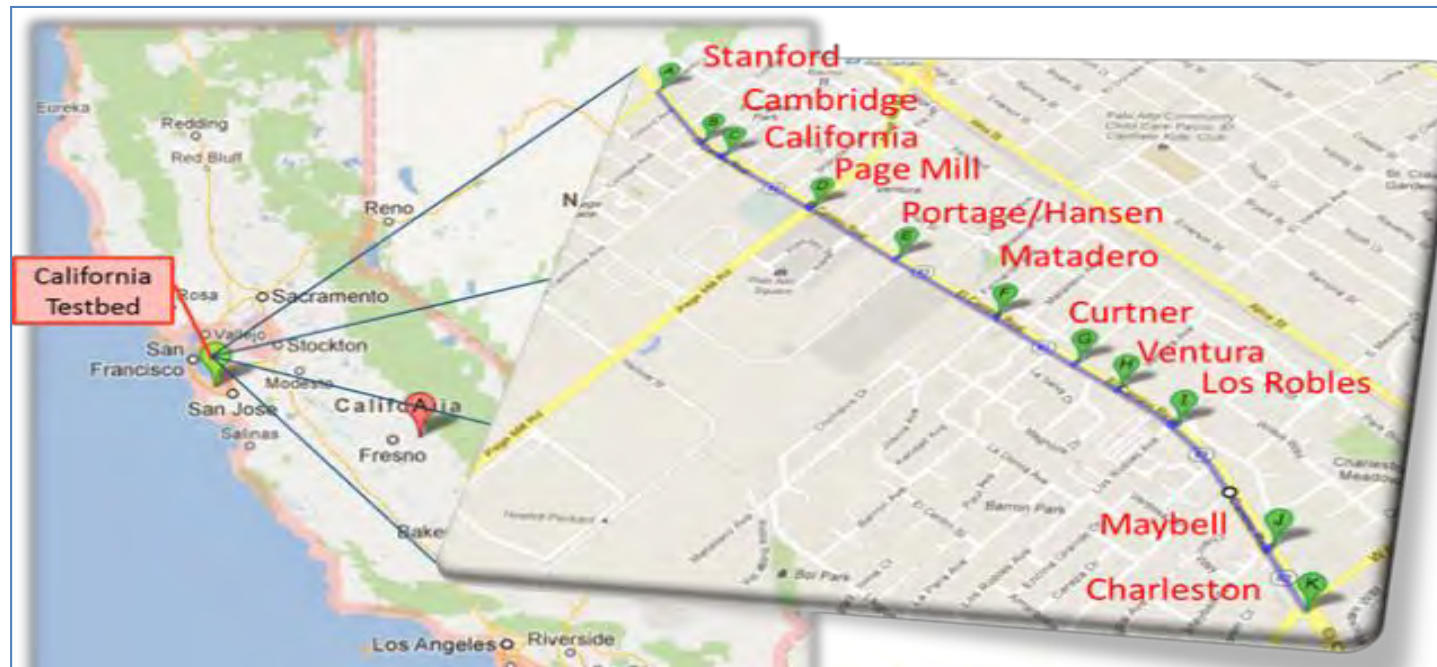

access

Testing & Tuning Phase

Proposed Service Corridor: Final test will be conducted on Westwood Blvd. in West Los Angeles connecting Greater VA Los Angeles Healthcare Center and Metro EXPO Line Westwood/Rancho Park Station - 2.9 Mile Route with Smart Infrastructure Sensors



access

Smart Infrastructure Phase

Smart Infrastructure will be built and implemented on the 2.9 mile service corridor. A combination of LiDar, camera, radar, ultra wide band sensor, BLE beacon, and DSRC will be installed and tested.

Vendors:

AECOM, Alcatel/Lucent, Deloitte & Touche, LA City DOT, Lilee Systems, UC Berkeley

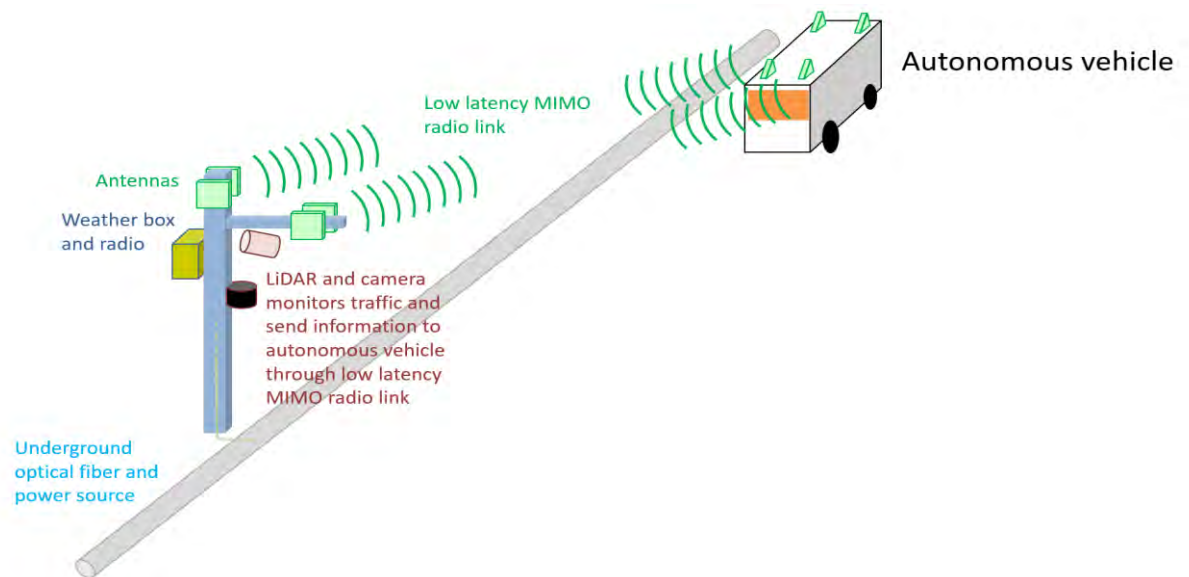

access

Operation Phase

Operations will start with First/Last Mile connector services first. If time and budget permit, on demand services will be tested within a geofenced area based on the $\frac{3}{4}$ mile expansion of the service corridor.

Vendors:

Alcatel/Lucent, Apollo Autonomous Driving, Deloitte & Touche, First Transit, LA City DOT, Lilee Systems, MV Transportation, Route Match, TripShot, UC Berkeley

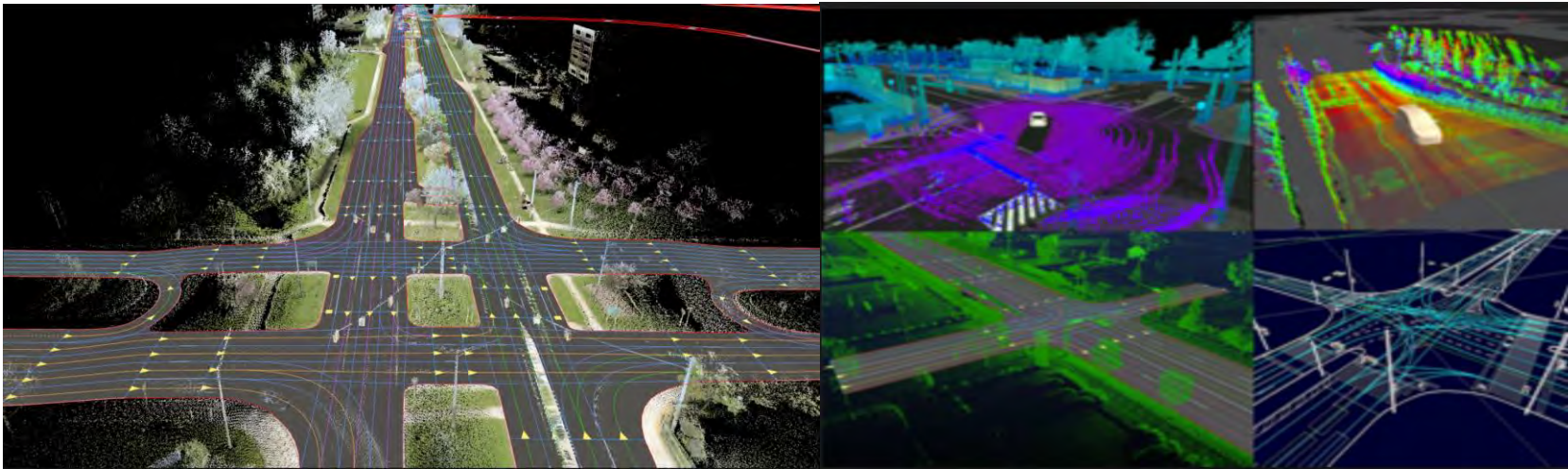

access

Project Wrap-Up Phase

The Project Wrap-Up phase will start toward the last three months of the project. Project completion report, policy/regulatory recommendations, operations manual, infrastructure suggestions, safety recommendations, assistive technology recommendations, lessons learned and final funding report will be prepared and provided to US DOT.

Vendors:

Deloitte & Touche, UC Berkeley

access

AAV Project Consortium Partners

Private Sector Partners: More than \$5M in-kind contributions pledged

- AECOM Technical Services: Infrastructure engineering & construction
- Alcatel Lucent Enterprise USA: Wayside data communication equipment
- Deloitte & Touche: Project audit and cybersecurity implementation
- First Transit: AV Operation, AV maintenance, AV depot
- Lilee Systems: AV technology, on board vehicle communication, smart infrastructure, AV vehicle monitoring center
- MV Transportation: AV Operation, AV maintenance, AV depot
- New Eagle: Vehicle electronic control unit and installation
- Route Match Software: Scheduling, dispatching, and ADA enabled user-centric mobility platform, including wayside guidance, real-time ETA
- Lonestar Handicap Vans - Retro-Fitting ADA Compliant Vehicles
- Wistron Corporation: GPU/CPU computing devices

AAV Project Consortium Partners

Public Sector Confirmed Partners:

- Los Angeles City Department of Transportation: Smart infrastructure, Traffic Signal Priority, V2I DSRC, Wayside Improvement
- City of Culver City Transportation Department: Potential Fixed Route Integration
- Santa Monica/Big Blue Bus: Potential Fixed Route Integration
- UC Berkeley - Testing & Tuning, data analytics, Safety Metric

Southern California Association of Governments
900 Wilshire Blvd., Suite 1700, Los Angeles, CA 90017

Agenda Item No. 4.2
January 29, 2020

To: Regional Transit Technical Advisory Committee (RTTAC)

From: Steve Fox, Senior Regional Planner, fox@scag.ca.gov

Subject: ADA Paratransit Demand Forecast

SUMMARY:

The Americans with Disabilities Act (ADA) mandates that providers of public transportation provide alternative curb-to-curb service for seniors and the disabled within three-fourths of a mile of their fixed route transit network. In May 2019, SCAG commenced work on the ADA Paratransit Demand Forecast. This report updates RTTAC members on the study's progress to date.

BACKGROUND:

Following the passage of the Americans with Disabilities Act of 1990, The FTA adopted four regulations to implement that statute, as well as the Rehabilitation Act of 1973. In particular, 49 CFR 37 mandated the provision of complementary paratransit for qualified individuals by providers of public transportation. This rule mandates that paratransit service shall be provided according to the following criteria:

- (a) Service Area—(1) Bus. (i) The entity shall provide complementary paratransit service to origins and destinations within corridors with a width of three-fourths of a mile on each side of each fixed route. The corridor shall include an area with a three-fourths of a mile radius at the ends of each fixed route.
- (ii) Within the core service area, the entity also shall provide service to small areas not inside any of the corridors but which are surrounded by corridors.
- (iii) Outside the core service area, the entity may designate corridors with widths from three-fourths of a mile up to one and one half miles on each side of a fixed route, based on local circumstances.
- (iv) For purposes of this paragraph, the core service area is that area in which corridors with a width of three-fourths of a mile on each side of each fixed route merge together such that, with few and small

exceptions, all origins and destinations within the area would be served.

Therefore, public transportation providers are mandated to provide complimentary paratransit service for trips within three-fourths of a mile of their fixed route service. This typically is provided by a dedicated paratransit vehicle picking the passenger up directly at their origin and dropping them off directly at their destination, from curb to curb. The mandate does not specify that the vehicle operator escort the passenger to or from the doorstep.

In addition to satisfying the ADA mandate, ADA Paratransit is also an important component of the Region's integrated mobility system. This service provides mobility for seniors and the disabled, many of whom cannot provide for themselves. However, since it typically operates at a rate of one vehicle operator to one passenger, this service is very resource intensive, resulting in very low productivity and very high costs per passenger hour and mile. For example, in FY2015-16, ADA Paratransit and other demand response services resulted in 18.1% of all public transit revenue vehicle hours, but less than 2% of all unlinked passenger trips in the region. In addition, average paratransit trip lengths have doubled between FY1991-92 and FY 2015-16.

DISCUSSION:

The ADA Paratransit Demand Forecast project includes the development of a forecasting tool to provide estimates of long-term demand for ADA paratransit trips, and also includes the production of an initial trip demand forecast for the years 2030 and 2045. The project includes significant outreach to partner agencies, and representatives of the elderly and disabled communities. Additionally, the study addresses the role of new mobility services in providing service to the elderly and disabled communities. The specific project tasks are:

Task 1 – Project Management

Task 2 – Stakeholder Engagement, including stakeholder interviews and focus groups

Task 3 – Data Collection, including an eligibility rules analysis, an existing conditions analysis and a review of technology and mobility innovations impacting paratransit

Task 4 - ADA Paratransit Demand Forecast Tool Development, including a forecasting tool instruction manual

Task 5 – Next Steps Analysis

Task 6 – ADA Paratransit Demand Costs, including cost estimates and long-term resource needs

Task 7 – Final Report

Study Progress to Date

Since the last project update to the RTTAC in September 2019, stakeholder outreach was conducted including interviews with various transit agencies. Those interviewed included Access Services, Gold Coast Transit District (GCTD), Ventura County Transportation Commission (VCTC), Imperial County Transportation Commission (ICTC), Omnitrans, Orange County Transportation Authority (OCTA), Riverside Transit Authority (RTA), and SunLine Transit Agency.

For Task 3, Data Collection, socioeconomic data has been collected and analyzed, and an eligibility rules analysis has been conducted looking at the eligibility rules used by different paratransit providers. Also, an analysis of existing systems performance is on-going, and the consultant completed its review of ADA paratransit demand forecast methodologies used by other paratransit providers in the industry. These include Massachusetts Bay Transportation Authority (MBTA), Miami-Dade Transit, Washington Metropolitan Area Transit Authority (WMATA) and Virginia Department of Rail & Public Transportation.

NEXT STEPS:

SCAG staff will periodically update RTTAC members during the course of the study. The project is expected to conclude in September 2020.



Southern California Association of Governments

ADA PARATRANSIT DEMAND FORECAST
Regional Transit Technical Advisory Committee
(RTTAC) Meeting



January 29, 2020

Agenda

- Study objectives and progress to date
- Key findings of interviews with ADA paratransit providers
- ADA paratransit forecast tool



MEETING OF THE

**REGIONAL TRANSIT
TECHNICAL ADVISORY
COMMITTEE**

*WEDNESDAY, JANUARY 29, 2020
10:00 A.M.*

SCAG OFFICES
900 WILSHIRE BLVD., STE. 1700
ROOM POLICY A
LOS ANGELES, CA 90017
(213) 236-1800

Study Objectives

- Develop a user-friendly, spreadsheet-based tool to forecast ADA paratransit demand through 2040 in the SCAG region, based on:
 - Literature review
 - Interviews with selected ADA paratransit providers
 - System performance
 - Eligibility rules
 - Technology and mobility innovations
 - Recent data provided by agencies
 - National Transit Database
 - Socioeconomic projections developed by SCAG
- Tool will be a part of the integrated suite of models used by SCAG for planning purposes
- Tool will support ADA paratransit providers in managing demand and identifying investments that can cost effectively meet ADA paratransit needs



Study Progress

- Task 2 – Stakeholder Engagement
 - Stakeholder engagement plan ✓
 - Stakeholder interviews ✓
 - Outreach to existing organizations (on-going)
 - Interagency coordination (on-going)
- Task 3 – Data Collection
 - Collect demographic data ✓
 - Eligibility rules analysis ✓
 - Document and analyze existing system performance (on-going)
- Task 4 – ADA Paratransit Demand Forecast Tool Development
 - Review of ADA paratransit demand forecast methodologies ✓

Agency Interviews

- Rationale for selection
 - Largest ADA paratransit providers within project constraints
- Agencies interviewed
 - Access Services, Los Angeles County
 - Gold Coast Transit District/Ventura County Transportation Commission, Ventura County
 - IVT Access/ICTC, Imperial County
 - Orange County Transportation Authority, Orange County
 - Omnitrans, San Bernardino County
 - Riverside Transit Agency, Riverside County
 - SunLine Transit Agency, Riverside County (Coachella Valley region)

SCAG ADA Paratransit Demand Forecast
INTERVIEW WITH GCTD

Tuesday, September 3, 2019
9:30 am – 10:30 am (PDT)
Conference call number: (408) 650-3123
Access Code: 893 552 061

ATTENDEES
Gold Coast Transit District
Margaret Heath-Schoep

HDR PROJECT TEAM
Bruno Penet, Project Manager
JD Douglas, Deputy Project Manager

AMMA
Heather Menninger
Valerie Mackintosh

SCAG PROJECT MANAGER
Stephen Fox

AGENDA

1. Introductions
2. Project Description and Goals
- Heather Menninger
3. Brief Overview of Project Approach
- Valerie Mackintosh
4. GCTD's ACCESS Paratransit Program
- Margaret Heath-Schoep
5. Review of Data and Information Requested
- Valerie and Heather
6. Discussion of Innovative Projects or Best Practices for Managing Demand
- All

Comparison of Eligibility Processes

Agency	Application	Healthcare Verification	In-person Interview	Functional Assessment
Access Services	✓	✓	✓	If necessary
GCTD/VCTC	✓	✓	✓	If necessary
IVT Access/ICTC	✓	✓	✓	✗
OCTA	✓	✗	✓	✓
Omnitrans	✓	✓	✓	✓
RTA	✓	✓	✗	✗
SunLine	✓	✓	✓	✓

Sources: Interviews with agencies, ADA eligibility applications and literature.

ADA Certifications

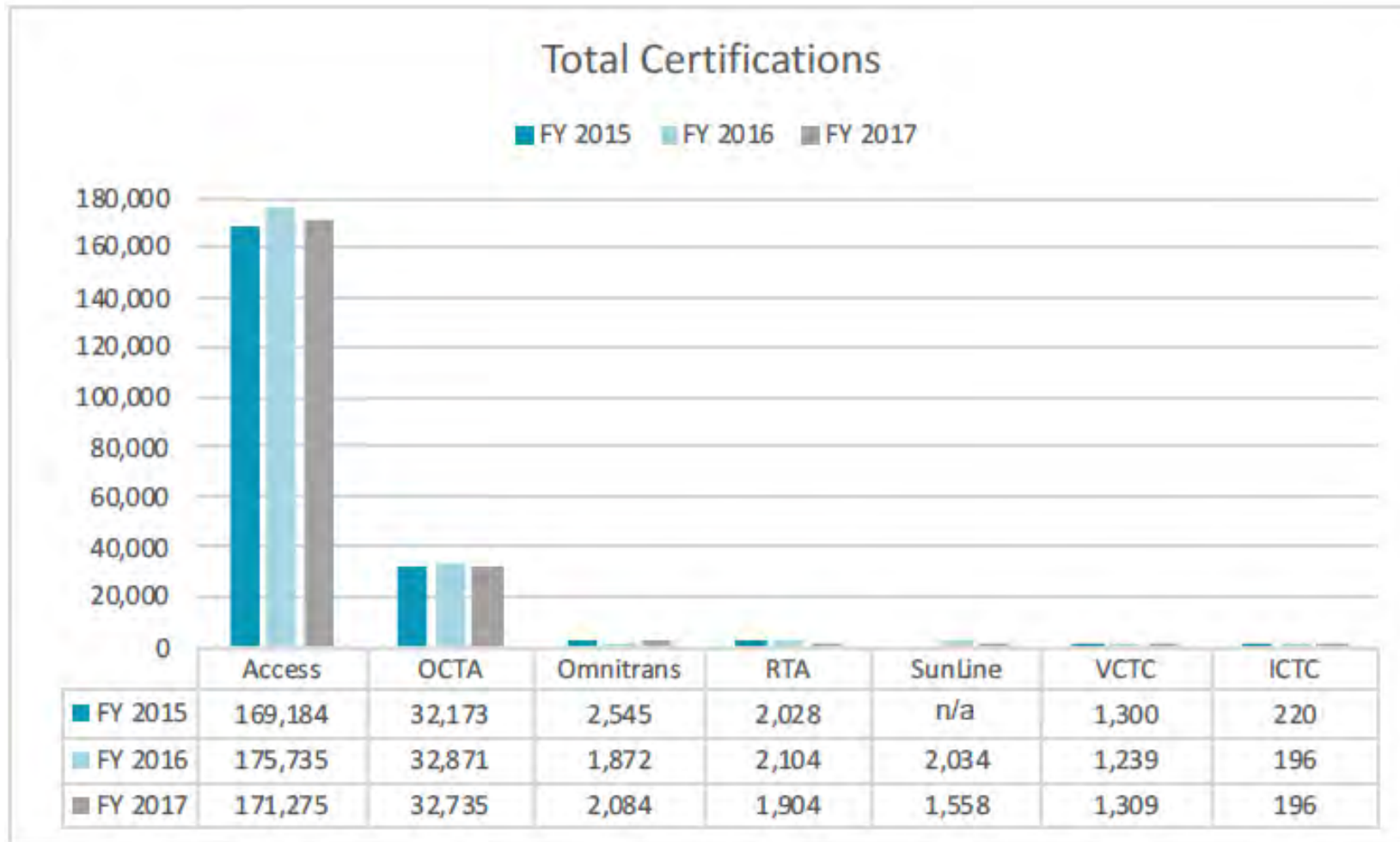

Key Findings

- Diversity of ADA paratransit providers in the SCAG region
 - Size (and available resources)
 - Operating environment

→ Differences are reflected in performance metrics

- Trips per capita
- Total certifications
- Certification denial rate
- Similarities in eligibility processes
 - Paper application
 - In-person interview
 - Recent emphasis on functional assessment

Agency	Access	OCTA	Omnitrans	RTA	VCTC	SunLine	ICTC
ADA Certifications	171,275	32,735	2,084	1,904	1,309	1,558	196
ADA Certification Denial Rate	5%	0.1%	2%	4.6%	0.1%	n/a	n/a

ADA Paratransit Forecast Tool

- Main goal
 - Forecast ADA paratransit demand through 2040 in the SCAG region
- Also support SCAG (and ADA paratransit providers in the SCAG region) in the areas of
 - Market analysis
 - Policy scenario analysis
 - Planning
 - Budgeting

Example of Methodology to Estimate Capacity Needs

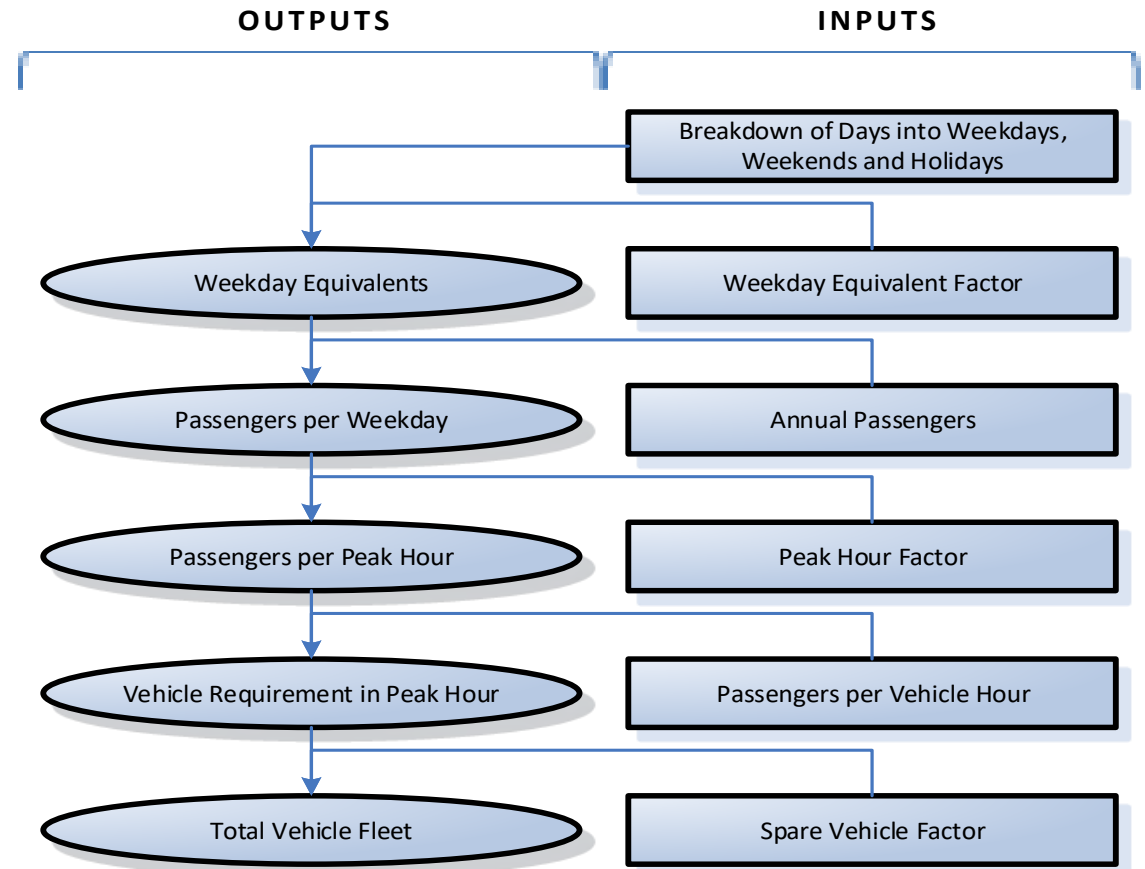

Key Characteristics

- Credible and reliable
 - Proven methodology
 - Sound data
 - Valuable results
- User-friendly and practical
 - Universally accepted format (MS Excel)
 - Minimal resources (time & skills) required
 - No formal training needed
- Flexible and scalable
 - Accommodates diverse needs
 - Applicable to different geographies
 - Ease of future updates

Example of Control Panel for Spreadsheet-Based Tool

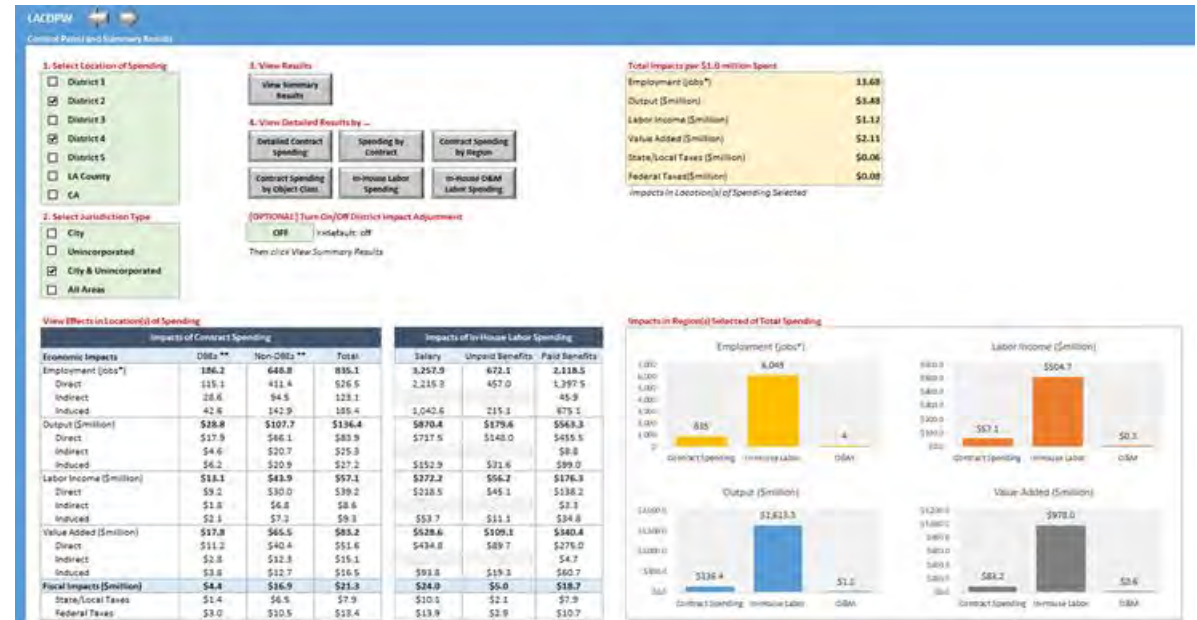

HDR

Southern California Association of Governments
900 Wilshire Blvd., Suite 1700, Los Angeles, CA 90017

Agenda Item 4.3
January 29, 2020

To: Regional Transit Technical Advisory Committee (RTTAC)

From: Steve Fox, Senior Regional Planner, 213-236-1855,
fox@scag.ca.gov

Subject: *Bus Rapid Transit in the SCAG Region*

SUMMARY:

This report updates RTTAC members on Bus Rapid Transit (BRT) operations and planning in the SCAG region. Several BRT projects are in the planning stages or have been implemented the last few years in several counties.

BACKGROUND:

BRT is bus transit service that reduces travel time through treatments such as transit signal priority (TSP), automatic vehicle location, dedicated bus lanes, limited-stop service, and pre-boarding fare payment. BRT service is often branded with its own fleet livery and stations. In the SCAG region, Los Angeles County Metropolitan Transportation Authority (L.A. Metro), Santa Monica's Big Blue Bus, Culver City Municipal Bus Lines (Culver City Bus), Omnitrans, Riverside Transit Authority and Torrance Transit operate varying levels of BRT. L.A. Metro's Orange Line is "true" BRT, operating exclusively on its own right-of-way and includes TSP and ticket vending machines at the stations. L.A. Metro's Rapid network runs along city streets in mixed-flow traffic lanes (there are some bus lanes on Wilshire Blvd., Figueroa and Flower Sts.), but benefits from TSP, unique branding and limited stops. Both services have reduced passenger travel time by up to 25% over the underlying Local service and have attracted new riders to transit. BRT is "scalable," meaning a transit agency can implement one or two of the basic attributes to their existing service at a low cost, resulting in considerable speed and quality of service improvements for its customers. Generally, transit agencies continue to run the underlying local service (but at perhaps less frequency than before) for those customers who are travelling shorter distances.

DISCUSSION:

Los Angeles County/"Metro Rapid"

L.A. Metro was the first transit agency in our region to implement BRT service in the summer of 2000. Metro Rapid service opened on Wilshire and Ventura Blvds. in 2000 to coincide with the opening of the Red Line subway to North Hollywood. BRT attributes include TSP, limited-stop service, unique branding, and dedicated stations. The two services were an immediate success, attracting many new riders to transit and connecting to the Red and Purple Lines. Culver City Bus, Santa Monica's Big Blue Bus, and Torrance Transit also started their own Rapid services as

part of L.A. Metro's overall countywide network of 29 corridors. Big Blue Bus runs three Rapids: Rapid 3 along Lincoln Blvd. between downtown Santa Monica and the Aviation Green Line station serving Los Angeles International Airport (LAX), Rapid 7 along Pico Blvd. between downtown Santa Monica and the Western Purple Line station, and Rapid 12 along Westwood Blvd. and Palm Ave. between UCLA and the Culver City E Line station. Torrance Transit runs its Rapid (Line 3) between downtown Long Beach and South Bay Galleria, and Culver City Bus runs its Rapid (Line 6) between UCLA and the Fox Hills Mall Transit Center along Sepulveda Blvd.

In 2014 Metro performed an analysis of each Rapid service comparing to its underlying Local service looking at speed advantage and stop spacing in particular. Metro staff found that many Rapids had lost or never achieved their designed 25% faster service and stop spacing of roughly a mile. Many Rapid corridors had Rapid stops added due to customer complaints and suggestions. As a result, Metro eliminated several of the Rapid corridors from service. Currently, L.A. Metro operates 18 Rapids.

Also, Metro has been planning its system-wide bus restructuring effort in order to reverse the ridership losses of recent years, dubbed "NextGen." The system redesign has been released with implementation later this year with Metro Board approval. The redesign eliminates almost all Rapid service, with the exception of Wilshire Blvd., Vermont Ave. and Van Nuys Blvd. In addition, BRT corridors are in the planning phases on Vermont Ave., and connecting the Red and Gold Lines through Burbank and Glendale.

Foothill Transit

Foothill Transit has been considering rolling out BRTs/Rapids upon the conclusion of the Metro NextGen study, but there were no SGV corridors selected for further study. Foothill Transit is planning to conduct a comprehensive operational analysis (COA) within the next year which will include a BRTs/Rapid feasibility study. Also the County of Los Angeles is leading a project to put TSP along Ramona Blvd, which is just beginning, and this might lead to a Rapid service.

Orange County/OCTA

OCTA started Bravo! limited-stop bus service in June of 2013, and now has three Bravo! routes. The first Bravo! was Route 543 which operates along Harbor Blvd. between the Fullerton Transportation Center and MacArthur Blvd. in Costa Mesa. Harbor Blvd. was chosen because it is one of Orange County's highest bus ridership corridors. The Bravo! service is not a full BRT service because it only uses the high-frequency, limited-stop, and unique branding service BRT elements. Each corridor has a local underlay service which provides more frequent stops and expanded span of service compared to the Bravo! service which operates mostly weekdays between 6:00 a.m. and 6:00 p.m. The second Bravo! route was implemented in 2016 on the Westminster Ave./17th St corridor between the Santa Ana Regional Transportation Center and

Long Beach. The third Bravo!, Line 529, was implemented last year on Beach Blvd. between Goldenwest Transportation Center and the Fullerton Park-and-Ride. Through the first quarter of fiscal year 2020, Route 529 carried 83,195 passengers, Route 543 carried 223,172 passengers and Route 560 carried 184,337 passengers.

OCTA has also implemented arterial “Xpress” services that operate limited-stop operations, including the 53X on Main St., Line 57X on State College Blvd. and Bristol St., and Line 64X on Bolsa Ave. and 1st St. Xpress service differs from Bravo! in that it does not have unique branding, route numbers, and additional resources were not added to these routes when they were implemented.

In 2020, OCTA will be exploring pilot projects on the Bravo! routes to improve the speed and amenity of the service. In 2023, OCTA will be upgrading the 53X service on Main St. to a Bravo! route using an SB1 Congested Corridors grant. The remaining Xpress services will be upgraded and new Bravo! routes will be introduced on several corridors in the future as funding becomes available.

Riverside County/RTA

In 2017, RTA identified the corridor between the University of California, Riverside (UCR) and Corona (University and Magnolia Blvds.), as a candidate for limited-stop service. This corridor has the highest ridership throughout RTA’s service area and has service every 15 minutes via Route 1. More than 9,000 customers use bus services along this corridor on weekdays. In August 2017, RTA introduced RapidLink Gold Line limited-stop service between UCR and Corona. RapidLink operates during peak periods every fifteen minutes and makes stops at key destinations. Fifteen bus stops were upgraded to include bus shelters with solar lighting, benches and trash cans as well as new RapidLink signage on the shelter roof. Base fares on RapidLink are \$1.75, the same price as RTA’s local fixed routes.

Ridership on RapidLink has not met anticipated projections but does continue to show growth. RTA did a focused campaign from July 1 to September 3, 2018 and utilized grant funding to provide free fares to all RapidLink riders. The campaign helped raise awareness about the route and provided an incentive for individuals to try public transportation. RapidLink has now been running for over two years, and between 2018 and 2019, ridership grew by over eight percent. Continued growth on RapidLink is needed in order to meet initial projections. Planning staff is currently designing an outreach program to receive feedback from riders who travel this corridor. Feedback will help shape any changes to the route structure, timing and bus stop locations as RTA looks to continue to improve ridership.

The UCR-Moreno Valley-Perris corridor is the second highest traveled corridor in RTA’s system. Currently, Route 16 runs service between UCR and Moreno Valley, and Route 19 runs service

from Moreno Valley to Perris. As of January 2020, Route 19 has 15-minute service during peak times, seven days a week. The addition of 15-minute weekday service has resulted in increased ridership that is still growing. Ridership has grown by over 27% on Route 19 since implementing 15-minute service. Route 16 also has 15-minute service during peak times seven days a week and has had over an 8% increase in ridership from 2018 to 2019. Ridership along these routes will be closely monitored and potential improvements such as TSP may be made along this corridor to better support the ridership growth.

SunLine Transit

As a key component of SunLine's COA (Rethink) currently underway, the agency is striving to make the current Route 111 corridor a HQTC corridor by implementing 15-minute or better service with TSP (a CVAG project) and other transit priority treatments. Currently, this frequency improvement is not funded, but through the COA restructuring process, operating efficiencies gained and with potential new funding sources, SunLine is intending to implement this much needed improvement as soon as possible. This improvement connects to CV-Link, the active transportation corridor running through the Coachella Valley. SunLine is proposing a Line 111 Express (111X) with very limited stops (just five stops) running hourly overlaying the current 111 service. The proposed implementation date is September 2020. It is projected to be 28% faster than Route 111 traveling the corridor in 62 minutes compared to the current 86 minutes.

San Bernardino County/Omnitrans

SBCTA's 2010 Long Range Transportation Plan identified 10 corridors within the county where BRT and Express service would be desirable. Number one on the list is the sbX, that opened in 2014. The sbX runs along a 15.7-mile corridor with transit signal priority between northern San Bernardino and Loma Linda serving Cal State San Bernardino, downtown San Bernardino and Loma Linda University Medical Center. It includes 60-foot, five-door articulated buses (the first in the U.S.) seating about 60 passengers; about six miles of bus-only lanes; 16 art-inspired stations at key university, government, business, entertainment and medical centers; and four park-and-ride lots.

Advancing in current planning phases are two additional corridors: The Foothill Blvd. corridor and the Holt Ave. corridor. This next BRT service is called the West Valley Connector, and is split in to two phases, Phase 1 and Phase 2. Phase 1 will run from the Downtown Pomona Metrolink Station to Victoria Gardens along Holt Blvd., and Milliken Ave., serving Ontario International Airport, Rancho Cucamonga Metrolink station and Ontario Mills Mall with 3.5 miles of bus only lanes in the city of Ontario. Phase 2 will run from Ontario International Airport to Kaiser Hospital in Fontana along Archibald Ave. and Foothill Blvd. serving downtown Fontana and the Fontana Metrolink station. Implementation of Phase 2 is based on funding availability.

Ventura County/Gold Coast Transit

Gold Coast transit is exploring the possibility of implementing a Route 6 Rapid. Route 6 is its most utilized route with about 950,000 boardings per year. The characteristics of the route would be limited-stop and follow the same path of the current Route 6 except that it wouldn't deviate into neighborhoods. The current Route 6 would become the Route 6 Local and would continue to serve the same areas but just at an hour headway. Gold Coast's goal for the Rapid is 20-minute headways. The Rapid would cut travel time between the Cities of Oxnard and Ventura significantly. Planning is still in the early phases.

NEXT STEPS:

SCAG staff will continue to provide support for regional BRT and rapid bus planning efforts, and periodically brief the RTTAC on developments in the region.

ATTACHMENT:

1. Bus Rapid Transit in the SCAG Region Presentation



Bus Rapid Transit in the SCAG Region

Steve Fox

Transit/Rail

RTTAC – January 29, 2020

www.scag.ca.gov



LACMTA Metro Rapid



- First Rapids in Summer of 2000 with Red Line opening.
- Full roll-out including Munis of 29 corridors by 2010.
- Big Blue Bus, Culver City and Torrance Transit part of Metro Rapid network.
- Periodic reviews have led to discontinuation or implementation of Rapids.
- Metro operates 18 Rapids currently.
- NextGen leaves just three L.A. Metro Rapids.

Los Angeles County



CP Hobbs photo

- Big Blue Bus operates Rapids 3, 7 and 12.
- Culver City Bus operates Rapid 6.
- Torrance Transit operates Rapid 3.
- Foothill Transit considering Rapid corridors.
- NextGen did not recommend Rapid corridors in San Gabriel Valley.
- County of Los Angeles planning for TSP on Ramona Blvd. which could lead to a Rapid service (Line 190).



Orange County – BRAVO!



- OCTA initiated Bravo! Rapid service in June 2013 with Line 543.
- Now three Bravos! – Lines 560 and 529.
- Line 529 started in 2019.
- OCTA has implemented three arterial “Xpress” services on Lines 53X, 57X and 64X.
- Xpress lacks branding and unique route numbering class.
- 53X planned to become Bravo! In 2023.

Riverside County - RTA



- First RTA Rapid started in summer of 2017 as “RapidLink” Gold Line.
- Line 1 flagship line between UCR and Corona.
- Ridership has not met expectations but is showing slow growth.
- Free fare marketing campaign in summer of 2018.
- The UCR–Moreno Valley–Perris corridor second best corridor in RTA service area. TSP and possible RapidLink service under consideration.

Riverside County - RTA

RapidLink Gold Line Ridership 2017 to Present

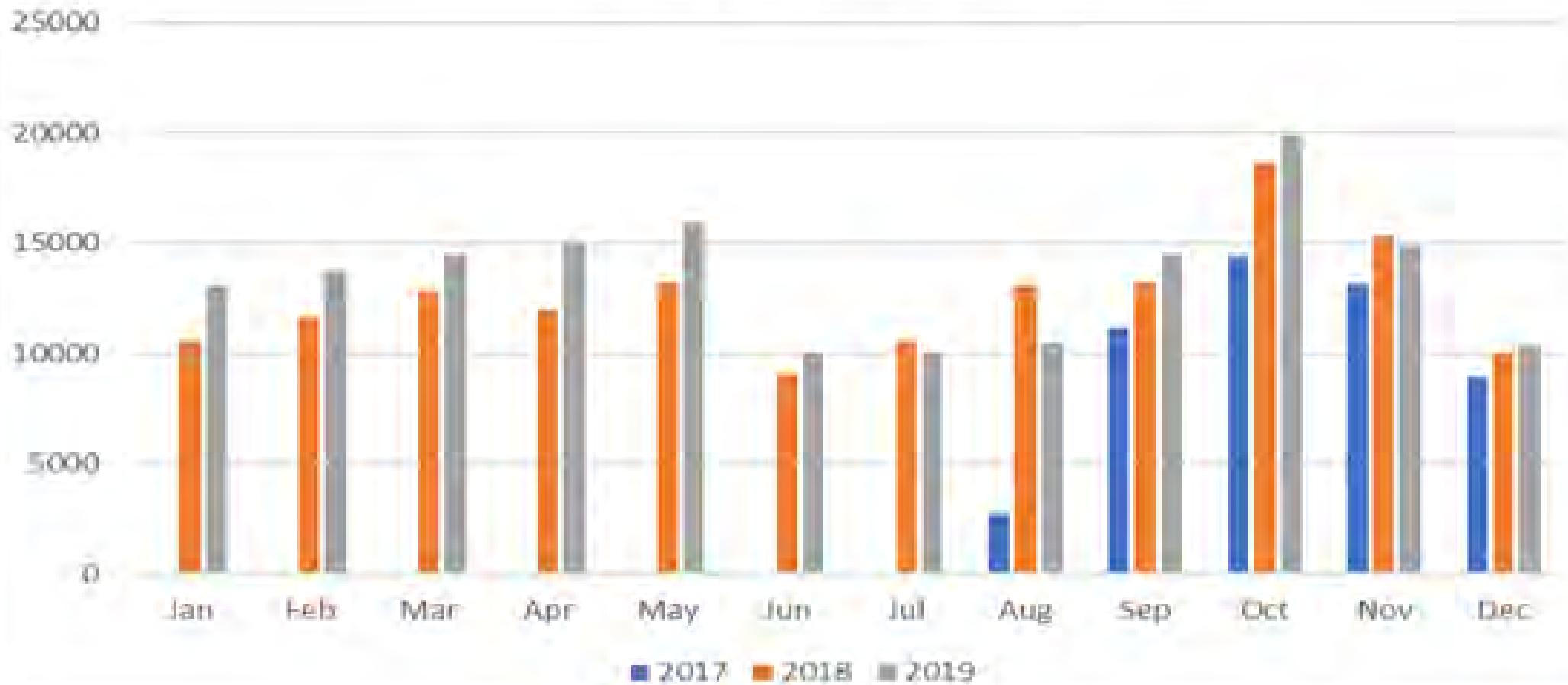

Riverside County - SunLine



- Line 111X Quick Bus/Limited Stop Service
- Proposed implementation September 2020
- Palm Springs to Indio
- 60-minute headways
- Just five stops at major transfer points
- 28% faster than Line 111
- 62 versus 86 minutes

Riverside County - SunLine



PROPOSED 111X SERVICE



San Bernardino County - Omnitrans



- sbX Green Line opened in 2014.
- Includes dedicated station platforms, TVMs, all-door boarding, TSP, and dedicated bus lanes.
- Ridership lower than projected but growing.
- SBCTA's 2010 LRTP identified ten Rapid and Express corridors.
- West Valley Connector Phases 1 and 2 in planning phase. (Phase 1 funded)

San Bernardino County - Omnitrans

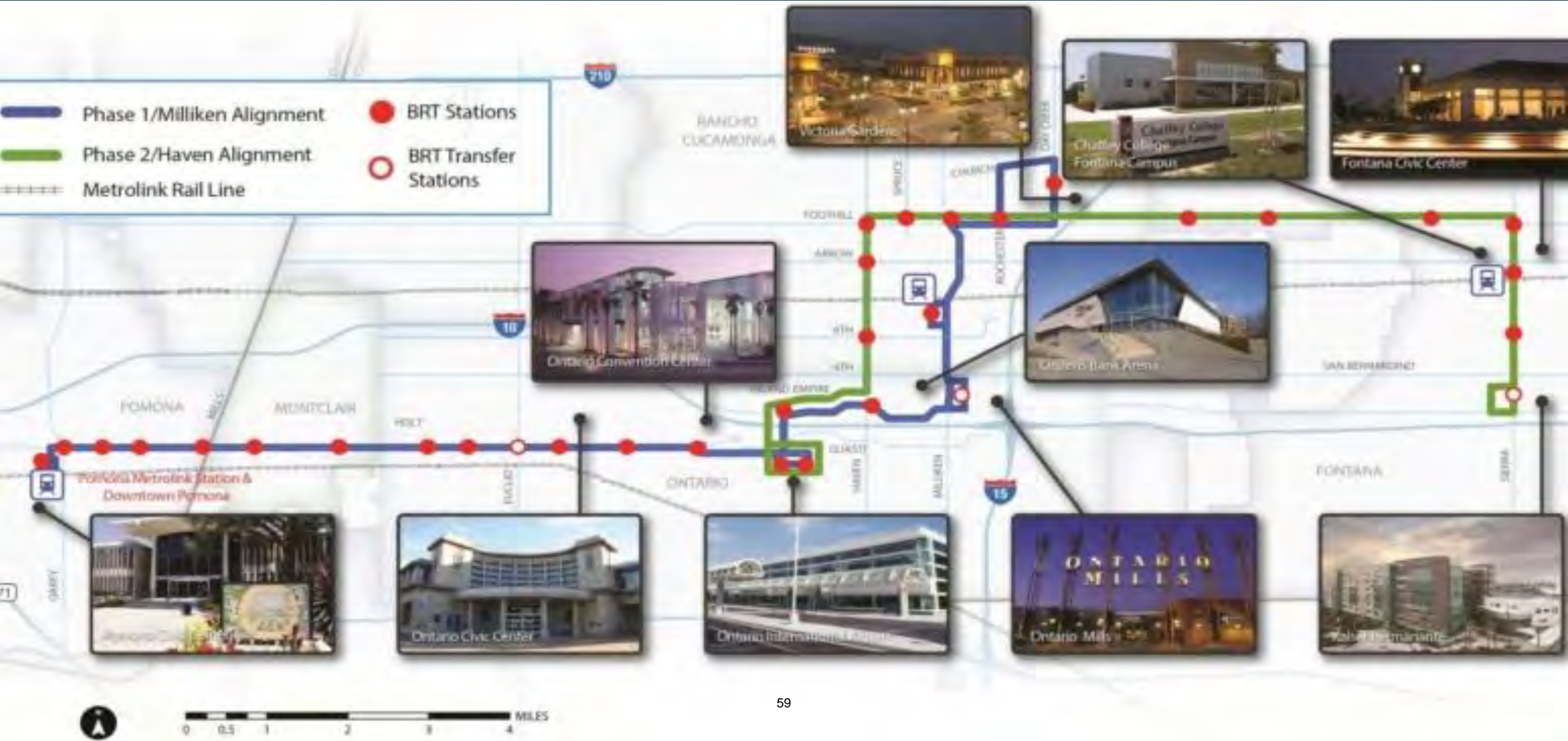

Ventura County – Gold Coast Transit



- Gold Coast planning for Route 6 Rapid service.
- Current Route 6 most heavily utilized route between Oxnard Transportation Center and downtown Ventura.
- Rapid would have 20-minute service.
- Local service would be reduced.
- No implementation date set.



Questions?

Steve Fox
fox@scag.ca.gov
213-236-1855
www.scag.ca.gov



Southern California Association of Governments
900 Wilshire Blvd., Suite 1700, Los Angeles, CA 90017

Agenda Item 4.4
January 29, 2020

To: Regional Transit Technical Advisory Committee (RTTAC)

From: Philip Law, Transit/Rail Manager, 213-236-1841,
law@scag.ca.gov

Subject: Assembly Bill 1560, Friedman. California Environmental
Quality Act: transportation: major transit stop.

SUMMARY:

On January 1, 2020, Assembly Bill (AB) 1560 became effective, revising the definition of major transit stop to include a bus rapid transit (BRT) station. Staff seeks input from the RTTAC regarding the methodology to identify BRT stations in accordance with AB 1560. Based on the analysis provided in this report, staff recommends adding a total of 20 additional BRT stations regionwide as major transit stops.

Following the input provided by the RTTAC, staff will update the methodology for major transit stops as documented in the Transit Technical Report for Connect SoCal, the 2020 Regional Transportation Plan/ Sustainable Communities Strategy (RTP/SCS). The Final Connect SoCal is scheduled to be adopted by the Regional Council on April 2, 2020.

DISCUSSION:

Over the past two years, SCAG staff and the RTTAC have engaged in discussions to update the methodology for identifying high quality transit corridors (HQTCs) and major transit stops for Connect SoCal. This culminated in a final methodology that was presented to the RTTAC in January 2019. The HQTCs and major transit stops that were identified using the methodology formed the basis for Connect SoCal assumptions and strategies, including the allocation of future population and employment growth in high quality transit areas (HQTAs), which are essentially ½ mile buffers around HQTCs and major transit stops.

Enactment of AB 1560 updates the definition of major transit stops to include BRT stations, as defined. AB 1560 revises the Public Resources Code Section 21064.3 to read:

“Major transit stop” means a site containing any of the following:

- (a) An existing rail or bus rapid transit station.
- (b) A ferry terminal served by either a bus or rail transit service.
- (c) The intersection of two or more major bus routes with a frequency of service interval of 15 minutes or less during the morning and afternoon peak commute periods.

AB 1560 adds Section 21060.2 to the Public Resources Code:

(a) “Bus rapid transit” means a public mass transit service provided by a public agency or by a public-private partnership that includes all of the following features:

- (1) Full-time dedicated bus lanes or operation in a separate right-of-way dedicated for public transportation with a frequency of service interval of 15 minutes or less during the morning and afternoon peak commute periods.
- (2) Transit signal priority.
- (3) All-door boarding.
- (4) Fare collection system that promotes efficiency.
- (5) Defined stations.

(b) “Bus rapid transit station” means a clearly defined bus station served by a bus rapid transit.

Uncertainty Regarding Dedicated Lanes

As written, the AB 1560 definition of BRT does not specify whether the full-time dedicated bus lanes must span the entire alignment of the BRT, or only part of the alignment. This is relevant to the SCAG region, where there are existing and planned BRT projects with full-time dedicated bus lanes on only a portion of the route. The National Transit Database (NTD) Policy Manual provides a definition of BRT that requires the bus to operate over 50 percent of the route in a dedicated bus lane. SCAG staff consulted with the AB 1560 author’s office, which indicated that the intent of the bill was to focus on how the dedicated bus lane applies to the bus stop. The intention was to ensure that buses that function like rail should benefit from the incentives given to major transit stops.

Existing and Planned BRT

SCAG staff identified the four existing and planned BRT projects in Connect SoCal that could potentially meet the AB 1560 definition and consulted with the county transportation commissions and transit operators regarding the project characteristics. Based on this consultation and staff’s research regarding dedicated lanes, there could potentially be four different options for identifying which BRT stations should be considered major transit stops:

1. The route must have dedicated lanes for the entire length (like the Metro Orange Line), and therefore every station qualifies as a major transit stop, or
2. The route must have over 50 percent dedicated lanes (consistent with the NTD definition of BRT), and every station qualifies as a major transit stop, or
3. The route must have over 50 percent dedicated lanes (consistent with the NTD definition of BRT), and only those stations with dedicated lanes qualify as a major transit stop, or

4. There must be dedicated lanes at the BRT station for that station to qualify as a major transit stop (ignores whether all or part of the route is in dedicated lanes).

Table 1 identifies the four BRT routes that meet the definition in AB 1560, and the number of stations that qualify as major transit stops under each of the four options. It should be noted that some of these routes already have stations that qualify as major transit stops, where they intersect with another HQT. This is indicated in the table where appropriate.

The existing Metro Orange Line and the planned Metro Vermont Corridor both have the entire alignment running in dedicated lanes, therefore all of their stations would qualify as major transit stops under all of the scenarios. The Omnitrans sbX Green Line and West Valley Connector Phase 1 have portions of their routes in dedicated lanes, but neither meets the 50 percent or 100 percent thresholds. The only scenario in which some of their stations qualify is under Option 4.

In this analysis, the results for Options 2 and 3 are no different than for Option 1. However, Options 2 and 3 may have relevance for future BRT projects, including some currently under study by Metro, which may have portions of their routes in dedicated lanes.

Table 1: BRT Stations Qualifying Under Different Methodologies

BRT Route	# of Stations Already Qualified as Major Transit Stops	# of <u>Additional</u> Stations That Would Qualify as Major Transit Stops Under AB 1560			
		Option 1: dedicated lanes for entire route, all stations	Option 2: >50% of route with dedicated lanes, all stations	Option 3: >50% of route with dedicated lanes, only stations w/lanes	Option 4: only stations w/lanes
Metro Orange Line	9	8	8	8	8
Vermont Corridor	15	2	2	2	2
sbX Green Line	1	n/a	n/a	n/a	5
West Valley Connector Phase 1	5 (2 existing plus 3 planned)	n/a	n/a	n/a	5

Staff Recommendation

Based on the analysis presented herein, the staff recommendation is to proceed with Option 4, in accordance with the author's intent for AB 1560 and their focus on how the dedicated bus lane applies to the bus stop. Under Option 4, both sbX and West Valley Connector Phase 1 would each have five additional BRT stations qualify as major transit stops. Metro Orange Line would have eight additional BRT stations qualify, and Vermont Corridor would have two additional BRT stations. In total, this adds 20 additional BRT stations regionwide.

In terms of impact to Connect SoCal, the total 20 additional BRT stations would be added as major transit stops to the HQTc and major transit stop maps. However, there would be no change to the HQTAs as a result of AB 1560, because the HQTAs already include the four BRT routes (alignment and stations) since they are HQTcs.

The methodology for identifying HQTcs and major transit stops is included in the Draft Connect SoCal Transit Technical Report as an Appendix, and it will be updated for the Final Connect SoCal to incorporate the changes from AB 1560. The definition of major transit stop will be updated to include BRT stations as defined in CA Pub. Res. Code Sections 21064.3 and 21060.2. A new BRT section will be added to the methodology, as follows:

BUS RAPID TRANSIT

As defined in statute, a BRT must include full-time dedicated bus lanes. In the SCAG region, there are existing and proposed BRT projects that have only a portion of their alignment in a full-time dedicated bus lane. For these BRT projects, only those stations that are adjacent to a full-time dedicated bus lane are considered major transit stops. For the BRT projects that have a full-time dedicated bus lane on their entire route, all of the stations are considered major transit stops.